

PT-100 Temperature Control Relay

- Wide operating Supply Range 24V to 240V AC/DC.
- Two analog outputs of 0 to 10V DC.
- Sensor Fault detection (open/short) indication through LED's as well as Analog outputs.
- LED Indications for power ON and relay ON status display.
- Adjustable wide temperature range from -50°C to 300°C through DIP switches.
- Auto/Manual reset mode selectable through DIP switch.
- Relay Normal/Inversion mode selectable through DIP switch.
- High load switching capacity of output up to 10A.





Ordering Information

Cat. No.	Description
47A3D412	-50°C to 300°C, 24V to 240V AC/DC, ±15%, 1C/O Relay O/P, Two Analog Outputs (0-10)VDC

PT-100 Temperature Control Relay



Cat. No.	47A3D412
Parameters	
Supply Voltage	24V to 240V AC/ DC (±15%)
Supply Frequency	50/60Hz
Power Consumption(Max)	For AC <5 VA For DC approx. 1W
Device Characteristics	
Max Lead Resistance Compensated in 3 wire Pt-100 Sensor	10 Ohm per Lead
Max Error in 2 wire Sensor	2.6°C per Ohm
Temperature Trip Accuracy	±1°C
Temperature Drift	Max 0.05°C/°C
Temperature Ranges	-50°C to 50°C, 0°C to 100°C, 100°C to 200°C, 200°C to 300°C
Set Point	0%-20%-40%-60%-80%-100%
Hysteresis	2%-5%-8%-11%-14%-17%-20%
Sensor Fault	Open and Short (Relay OFF)
Sensor Fault Detection Time	<500 ms
Sensor Fault Recovery Time	1.8 to 2 sec.
Output Characteristics	
Contact Arrangement	1 C/O
Contact Ratings	10A @ 250VAC / 30VDC, 4KV Isolation between Coil & Contact.
Utilization Category	AC-15: 3A/250VAC
Response Time(Trip Delay)	min 600 ms to 1 sec
Analog Output Details	
Measured Point (Y1)	(0-10) VDC ± 200 mV
Set Point (Y2)	(0-10) VDC ± 100 mV
In case of sensor Fault (Open/Short) Measured Point output (Y1) is 12VDC.	
Ambient Conditions	
Operating Temperature	-10°C to +55°C
Storage Temperature	-15°C to +60°C
Relative Humidity	5 to 85% RH(non-condensation)
Degree of Protection	IP 20 for terminals & IP 40 for Enclosure
Max. Altitude	2000 m
Pollution Degree	II
Type of Insulation	Reinforced
Certification	 

EMI/EMC Compliance

Harmonic Current Emission	IEC 61000-3-2
ESD	IEC 61000-4-2
Radiated Susceptibility	IEC 61000-4-3
EFT on Supply	IEC 61000-4-4
EFT on I/P & O/P signal	IEC 61000-4-4
Surge	IEC 61000-4-5
Conducted Susceptibility	IEC 61000-4-6
Voltage Dips & Interruptions (AC model)	IEC 61000-4-11
Voltage Dips (DC model)	IEC 61000-4-29
Conducted Emission	CISPR 14-1
Radiated Emission	CISPR 14-1

Safety Compliance:

Dielectric test voltage between I/P & O/P	IEC 60947-5-1
Impulse Voltage between I/P & O/P	IEC 60947-5-1
Single Fault Test	IEC 61010-1
Insulation Resistance	UL 508
Leakage Current	UL 508

Environmental Compliance:

Cold Heat	IEC 60068-2-1
Dry Heat	IEC 60068-2-2
Vibration	IEC 60068-2-6
Non-Repetative Shock	IEC 60068-2-27

PT-100 Temperature Control Relay



SELECTION OF TEMPERATURE RANGE & MODE

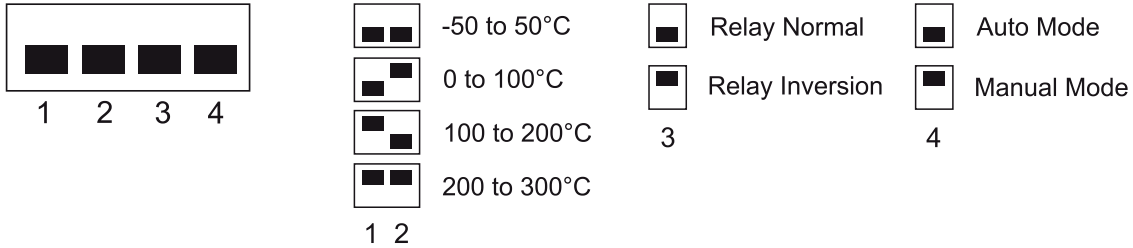

FUNCTION DIAGRAM

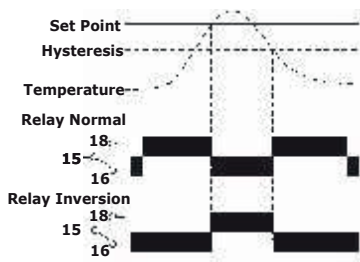

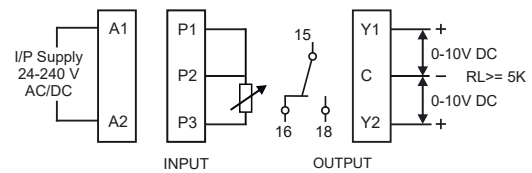

CONNECTION DIAGRAM

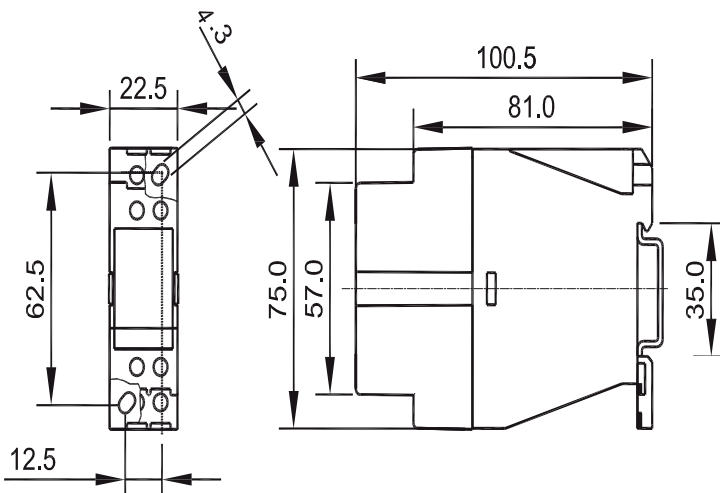

MECHANICAL DIMENSIONS

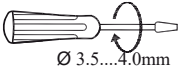

TERMINAL TORQUE & CAPACITY

 Ø 3.5...4.0mm	0.6 N.m (5.3 Lb.in) Terminal screw - M3
	1 x 0.5...6mm ² Solid Wire
WG	1 x 20 to 10