

### SIDE-LOOK PACKAGE LIGHT EMITTING DIODE

● **Features:**

1. Selected to specific on-line intensity and radiant intensity ranges.
2. Low cost, plastic side looking package
3. Lens Appearance: Water Clear.
4. This product doesn't contain restriction substance, comply RoHS standard

● **Applications:**

1. Mouse
2. Automatic Control System.

● **Package Dimensions:**

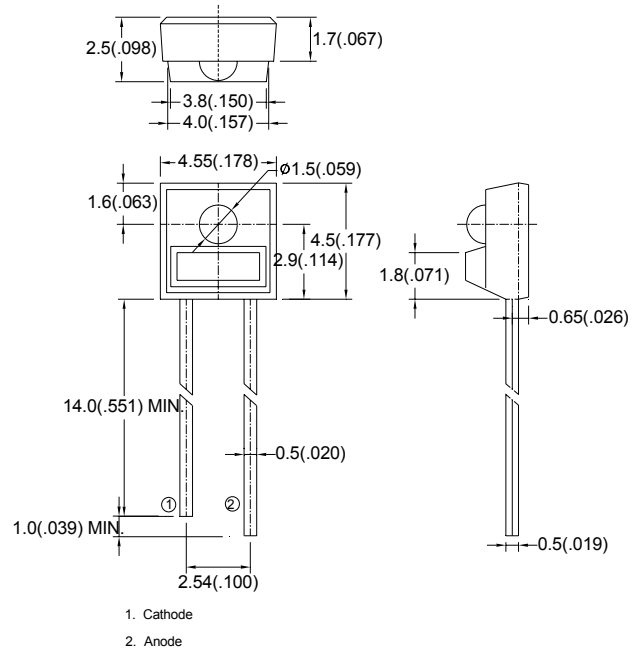

**NOTES:**

1. All dimensions are in millimeters (inches).
2. Tolerance is  $\pm 0.25$ mm (0.01') unless otherwise specified.
3. Lead spacing is measured where the leads emerge from the package.
4. Specifications are subject to change without notice.

● **Absolute Maximum Ratings(Ta=25°C)**

Parameter	Symbol	Rating	Unit
Power Dissipation	Pd	75	mW
Continuous Forward Current	I <sub>F</sub>	50	mA
Peak Forward Current <sup>*1</sup>	I <sub>FP</sub>	1.0	mA
Reverse Voltage	V <sub>R</sub>	5	V
Operating Temperature	Topr	-45°C~85°C	-
Storage Temperature	Tstg	-45°C~100°C	-
Soldering Temperature	Tsol	260°C (for 5 seconds)	-

\*1 Condition for is I<sub>FP</sub> pulse of 1/10 duty and 0.1 msec width.

### ● Optical- Electrical Characteristics (@ $T_A=25^\circ\text{C}$ )

Parameter	Symbol	Test Conditions	Min	TYP	Max	Unit
Radiant Intensity	Ee	$I_f=4\text{mA}$	0.4	0.65	-	$\text{mW}/\text{cm}^2$
Forward Voltage	$V_F$	$I_f=20\text{mA}$	-	1.20	1.50	V
Reverse Current	$I_R$	$V_R=5\text{V}$	-	-	100	$\mu\text{A}$
Peak Wavelength	$\lambda_p$	$I_f=20\text{mA}$	-	940	-	nm
Spectral Line Half- Width	$\Delta \lambda$	$I_f=20\text{mA}$	-	50	-	nm
Viewing Angle	$2\theta_{1/2}$	$I_f=20\text{mA}$	-	45	-	deg

### ● Typical Optical-Electrical Characteristic Curves

FIG.1 Spectral Distribution

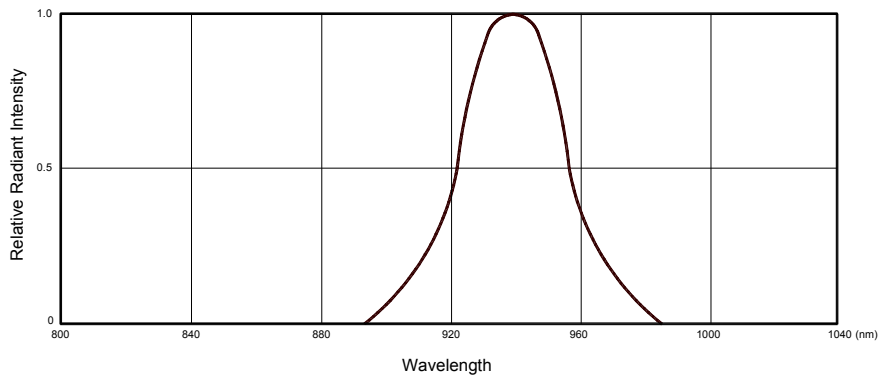

FIG.2 Forward Current Vs. Forward Voltage

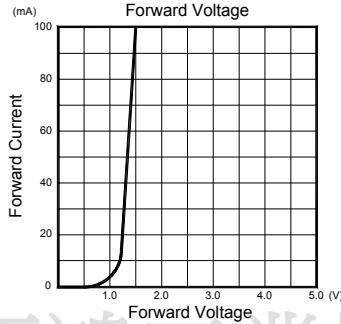

FIG.3 Relative Radiant Intensity Vs. Ambient Temperature

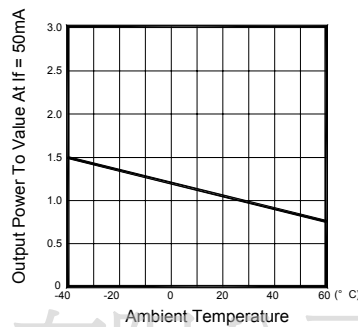

FIG.4 Relative Radiant Intensity Vs. Forward Current

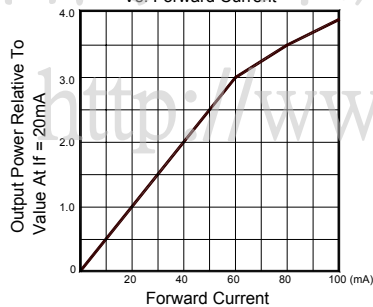
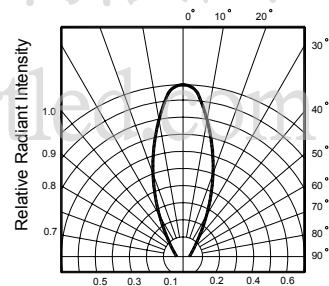
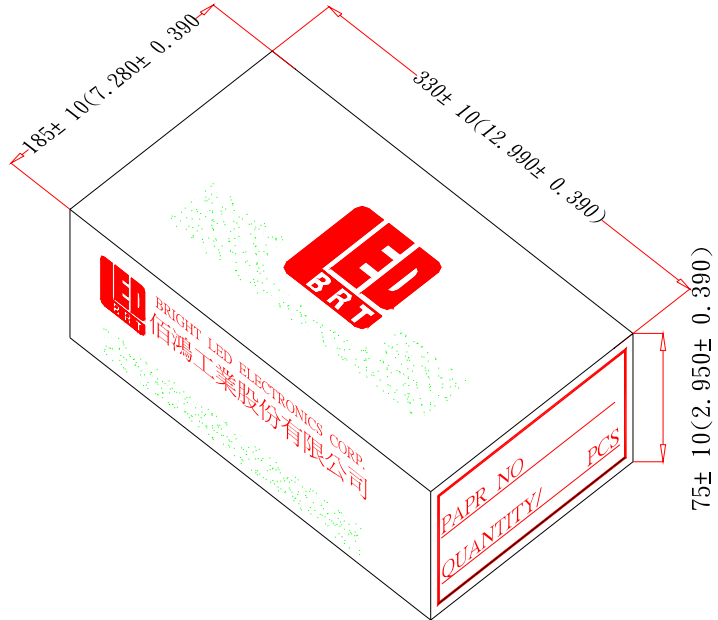

FIG.5 Radiant Diagram



● Tapping and packaging specifications(Units: mm)



● Packaging Bag Dimensions

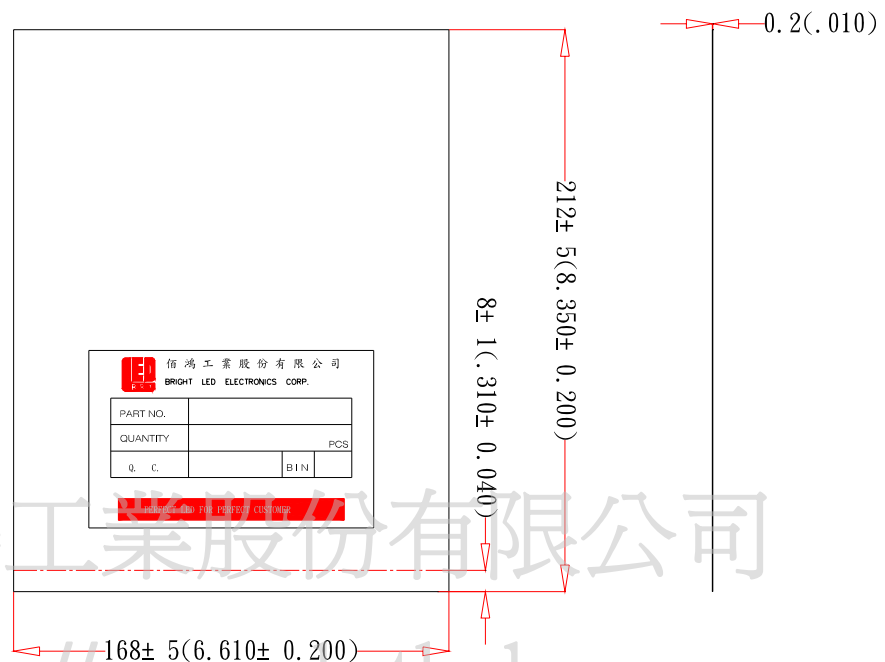

Notes:

- 1、1000pcs per bag, 8Kpcs per box.
- 2、All dimensions are in millimeters(inches).
- 3、Specifications are subject to change without notice.

<http://www.brtled.com>